

The Salt Meadow



Rendering is Artist's Conception

B R E A K W A T E R

Standard Floor Plan

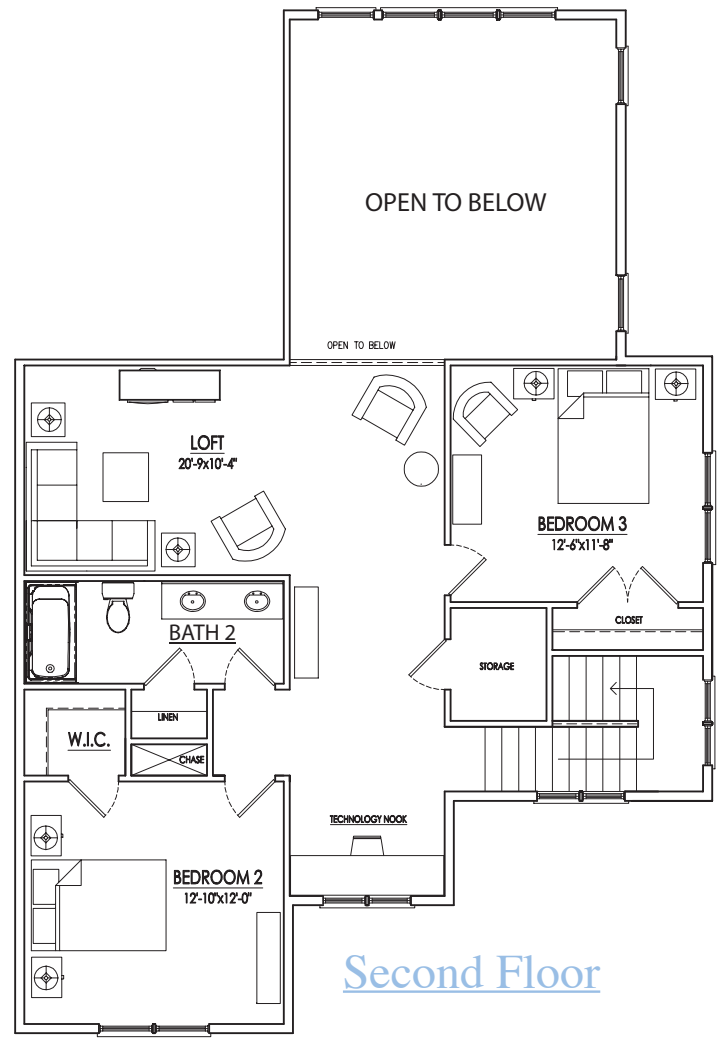
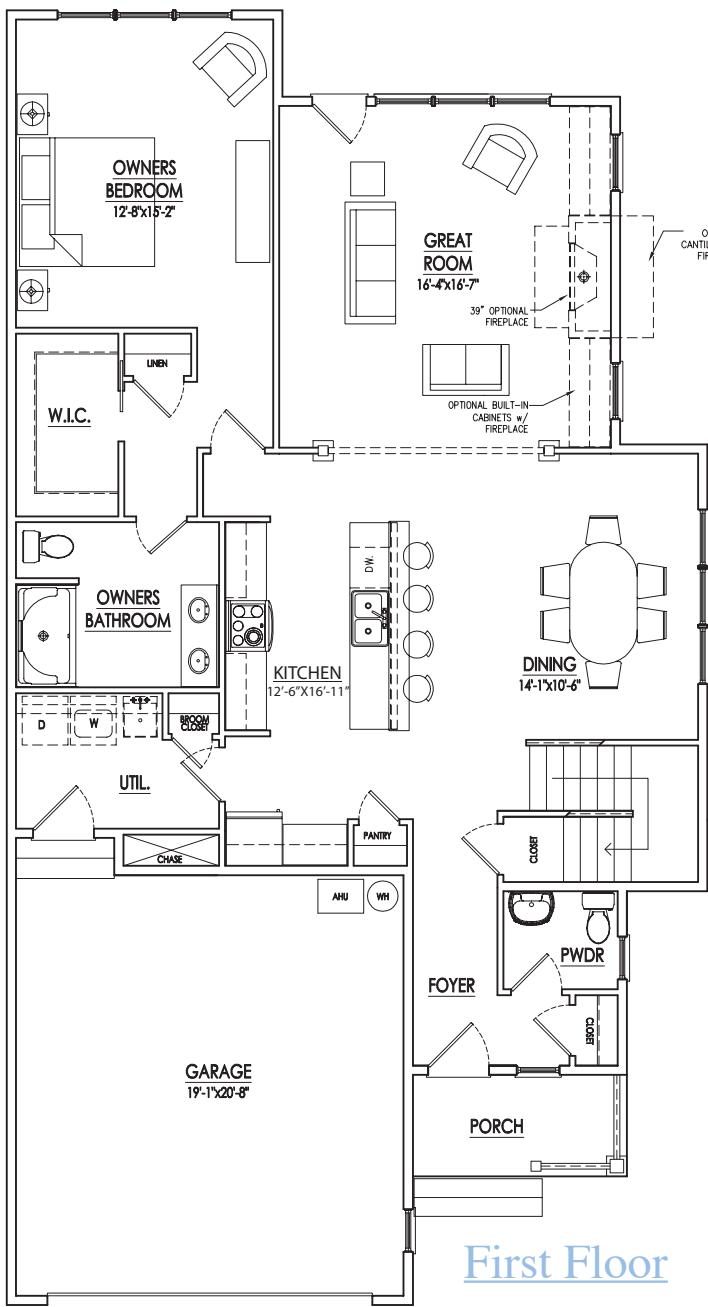

The Salt Meadow

| | |
|----------------|-------------|
| Beds | 3 - 4 |
| Bath | 2.5 - 3.5 |
| Heated Sq. Ft. | 2362 - 2536 |
| Total Sq. Ft. | 2844 - 3018 |

Structural Options

| | |
|------------|------|
| Sunroom | +176 |
| Bedroom #4 | +285 |

* Floorplan dimensions are approximate.

Structural Options

OPTIONAL BEDROOM #4

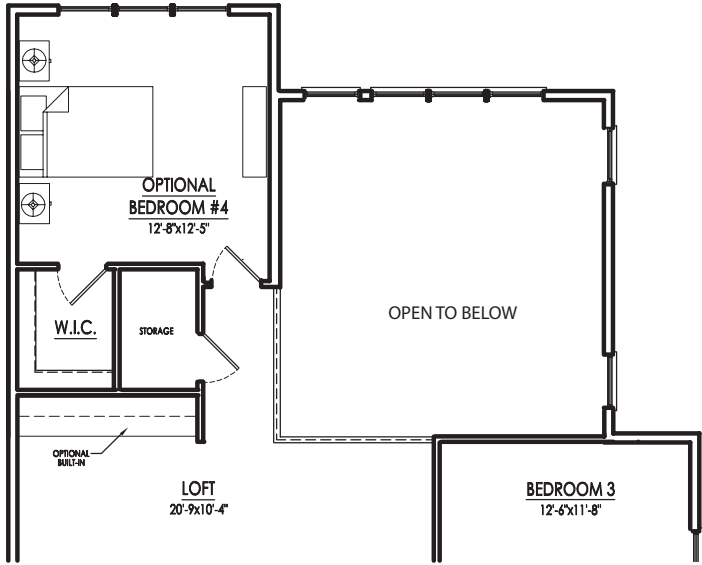

OPTIONAL SUNROOM

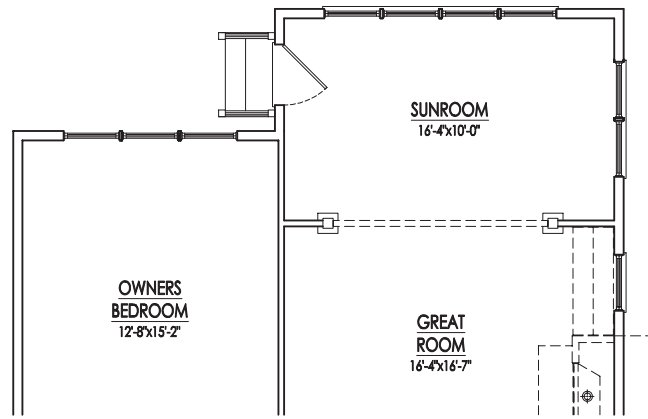

OUTDOOR SHOWER OPTIONS

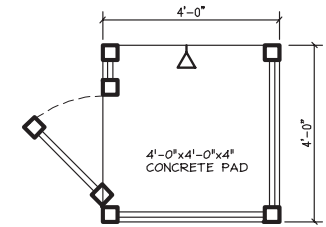

4' X 4' OUTDOOR SHOWER

To be located between Great Room windows or behind foyer closet if cantilevered

OPTIONAL SUNROOM W/ OPTIONAL DECK I

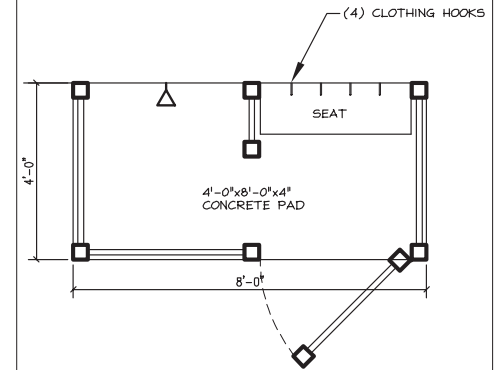
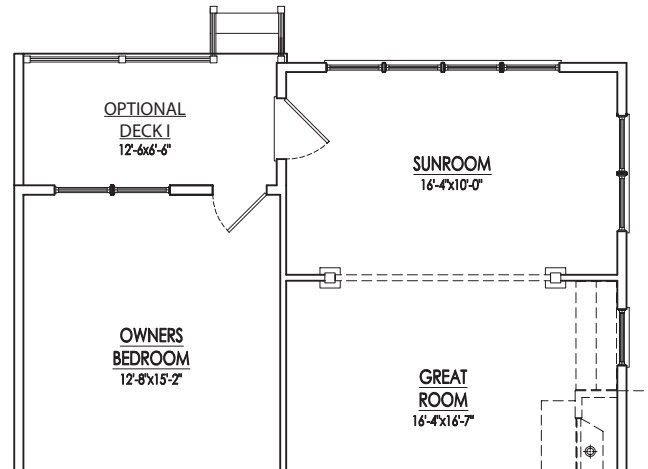

4' X 8' OUTDOOR SHOWER

To be located behind staircase wall.

OPTIONAL BEDROOM #4 W/ BATHROOM #3

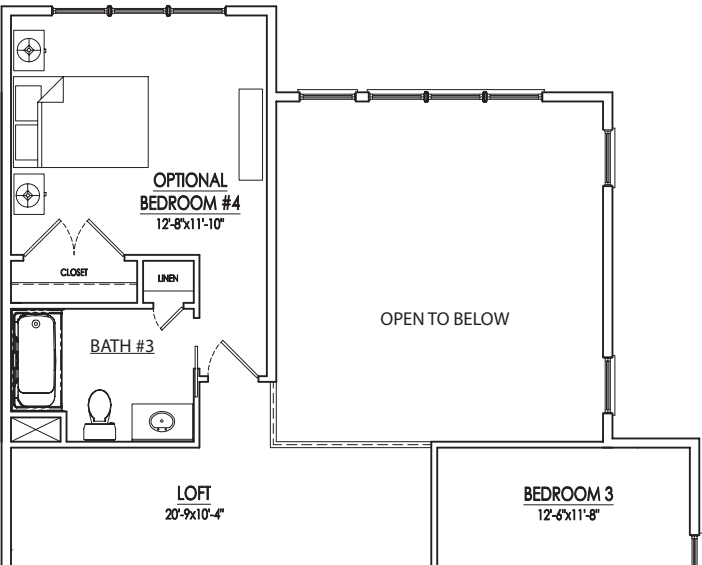

Additional Options on Back 

* All information is subject to change without notice.

Structural Options

