

# The Sea Spray



Rendering is Artist's Conception

B R E A K W A T E R

# Standard Floor Plan

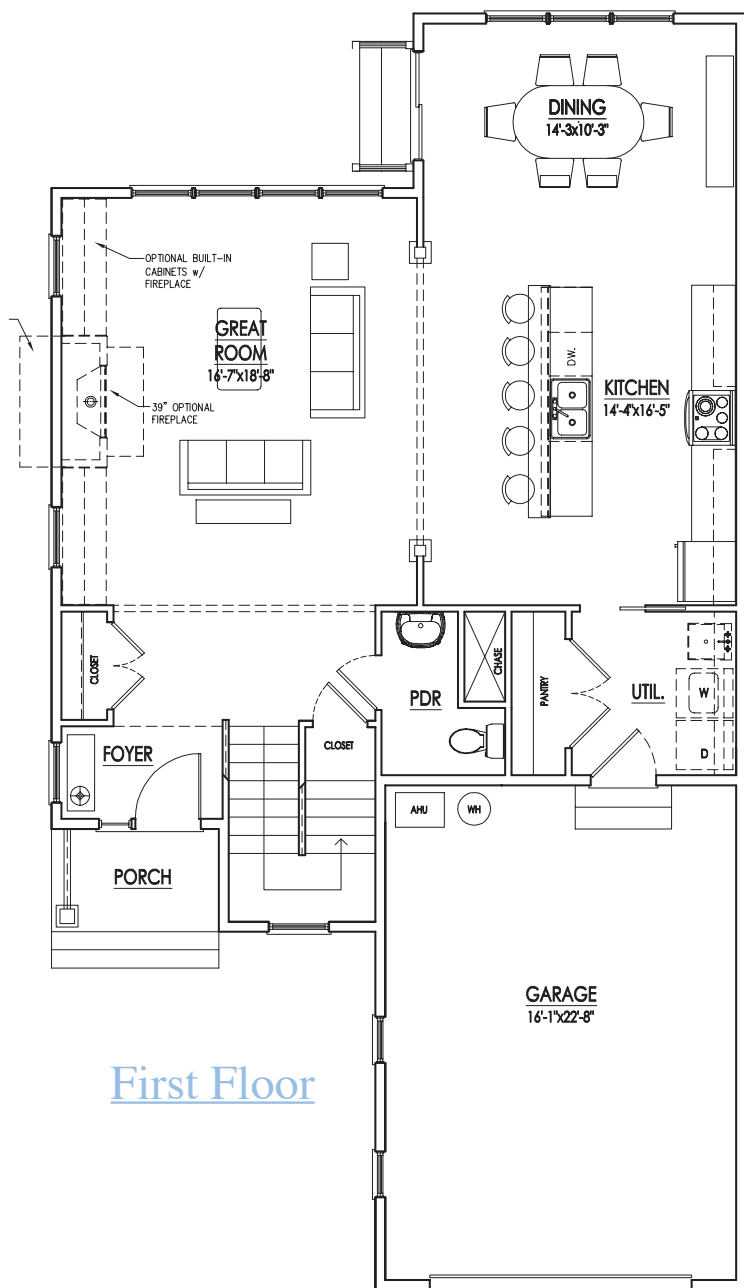

First Floor

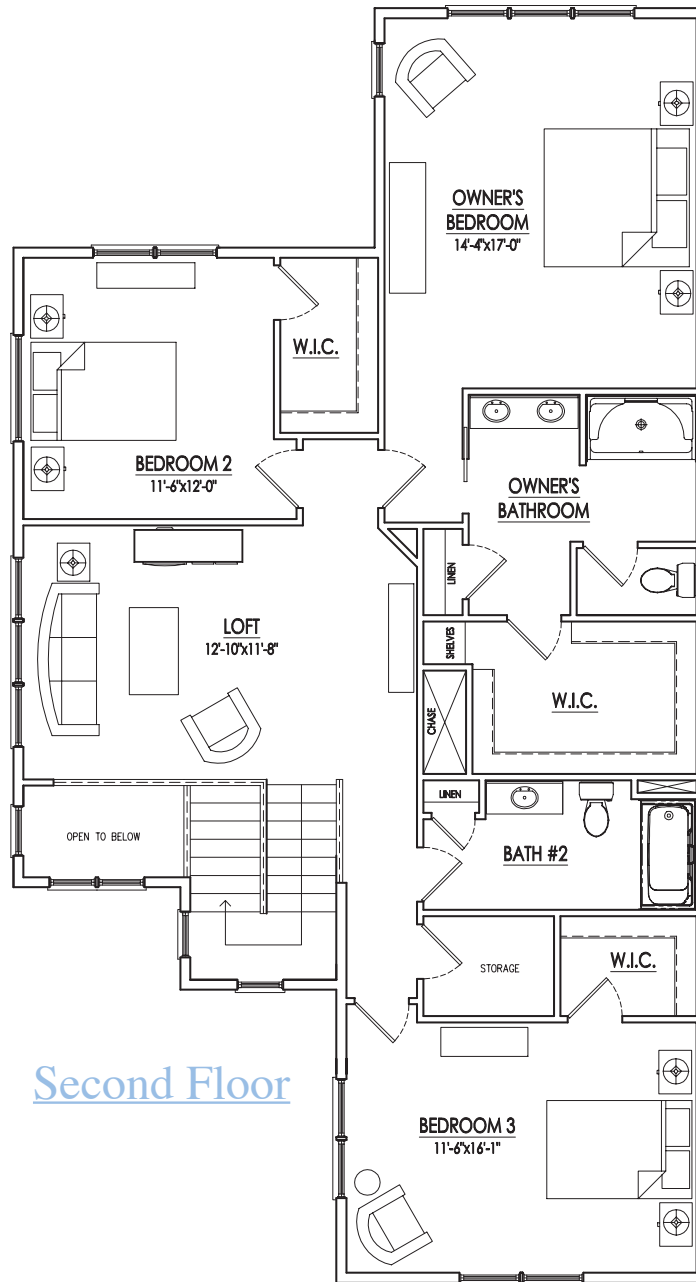

Second Floor

## The Sea Spray

Beds 3 - 4  
Baths 2.5

Heated Sq. Ft. 2406 - 2571

Structural Options  
Sunroom +155

\* Floor plan dimensions are approximate.

# Structural Options

## OUTDOOR SHOWER OPTIONS

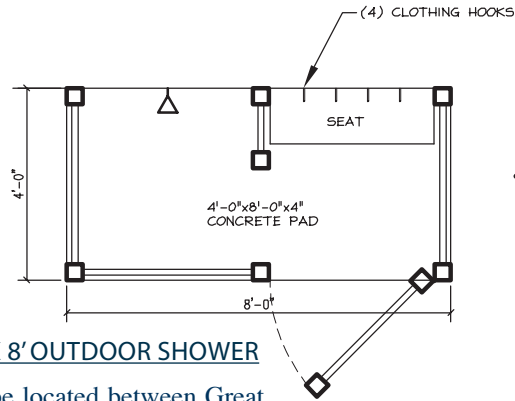

**4' X 8' OUTDOOR SHOWER**

To be located between Great Room windows.

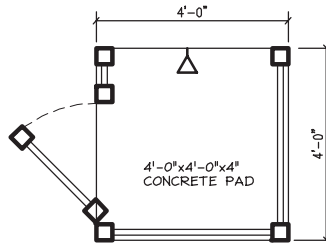

**4' X 4' OUTDOOR SHOWER**

To be located between Great Room windows or behind foyer closet if cantilevered fireplace option is selected.

## OPTIONAL SUNROOM

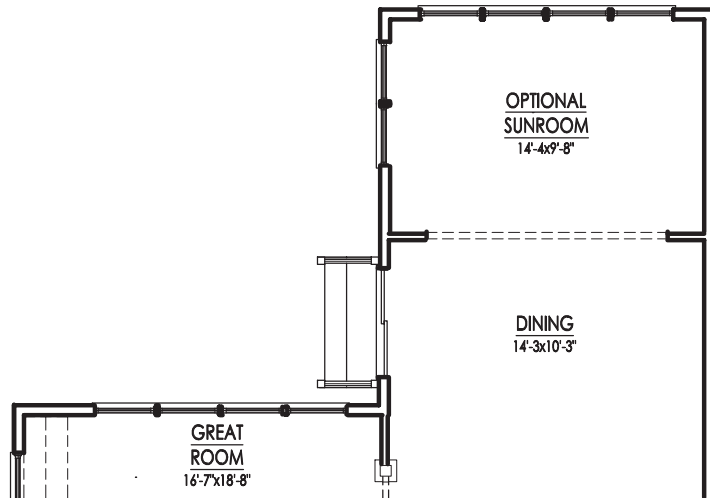

## OPTIONAL BEDROOM #4

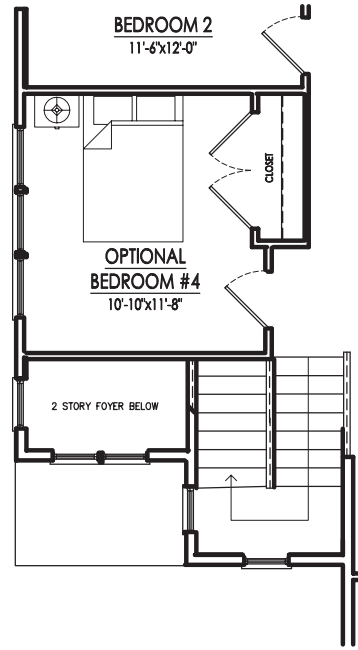

## OPTIONAL OWNER'S LUXURY BATH

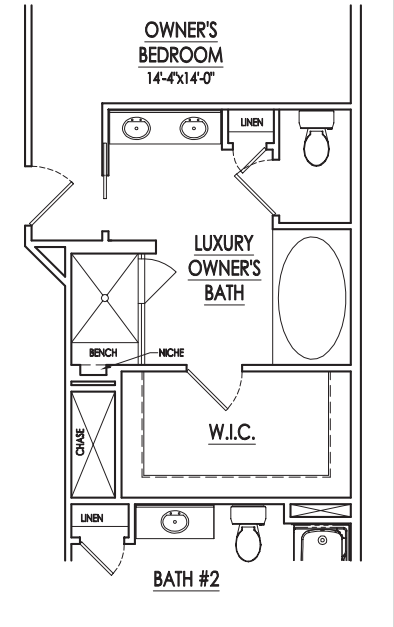

Additional  
Options on Back



# Structural Options

