

The Salt Meadow



Rendering is Artist's Conception

B R E A K W A T E R

Standard Floor Plan

The Salt Meadow

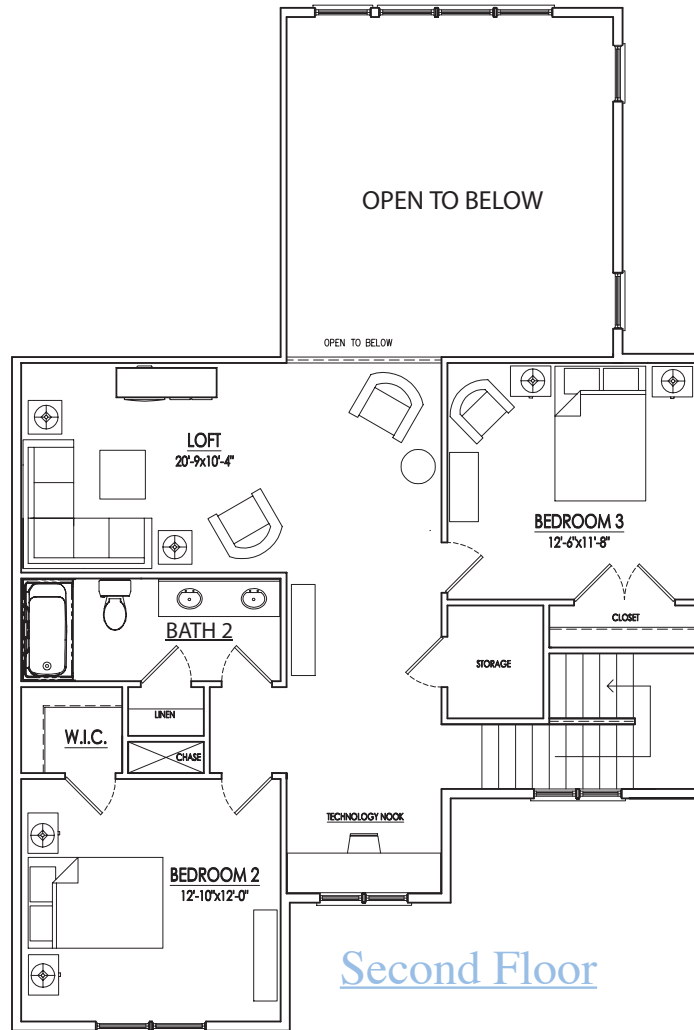
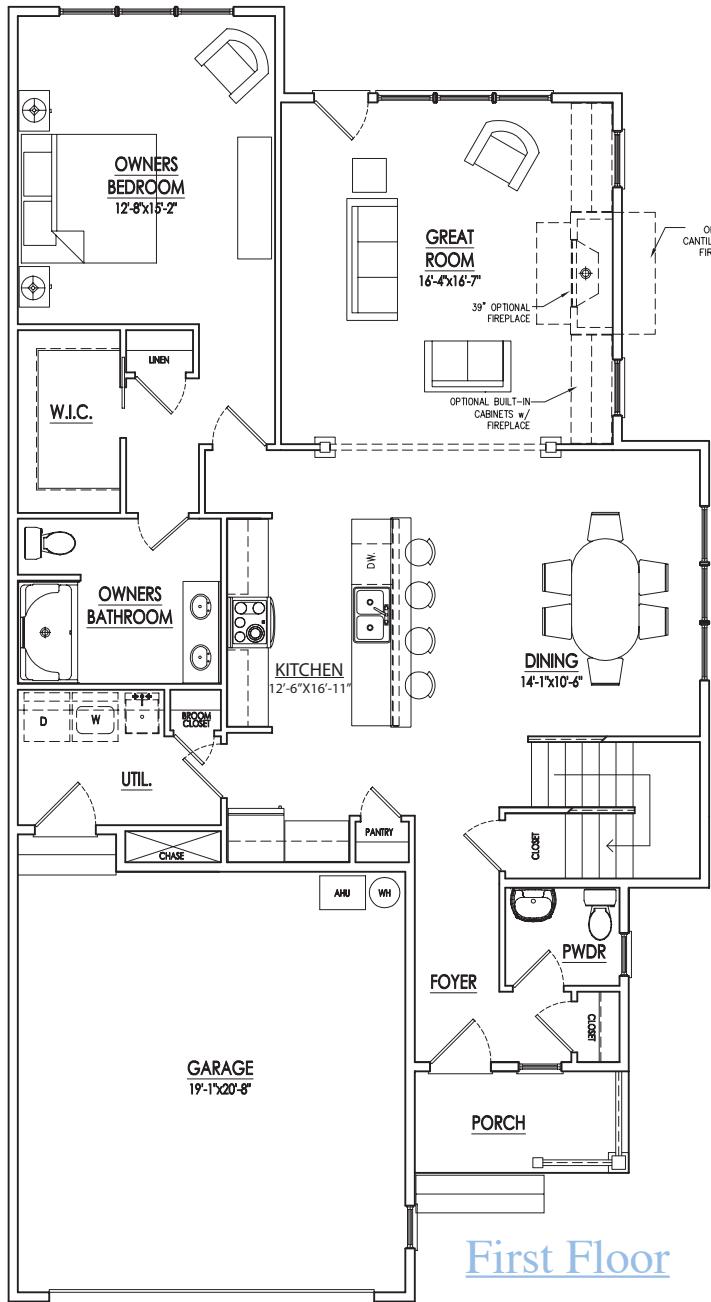

Beds 3 - 4
Bath 2.5 - 3.5

Heated Sq. Ft. 2298 - 2583

Structural Options

Sunroom +176
Bedroom #4 +285

* Floor plan dimensions are approximate.

Structural Options

OPTIONAL BEDROOM #4

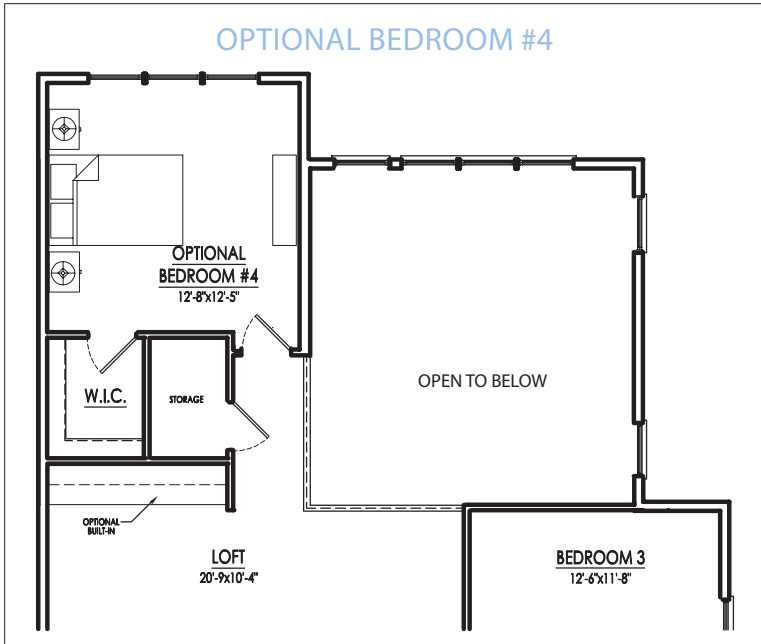

OPTIONAL SUNROOM

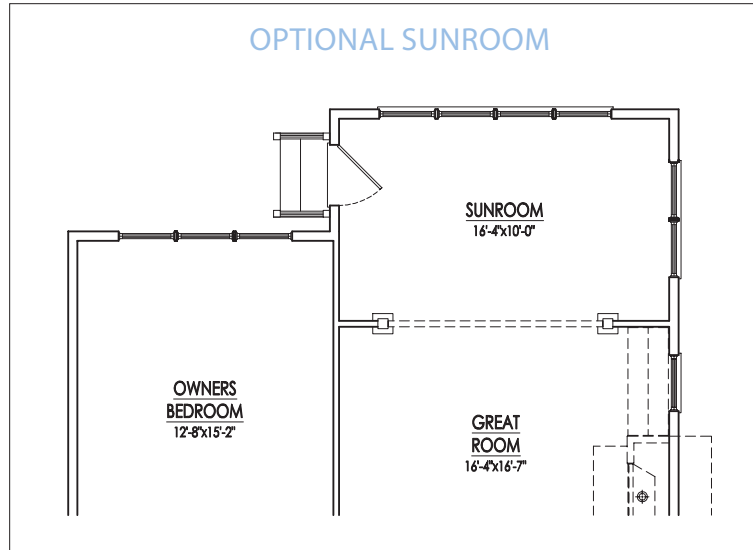

OUTDOOR SHOWER OPTIONS

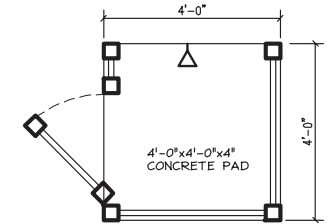

4' X 4' OUTDOOR SHOWER

To be located between Great Room windows or behind foyer closet if cantilevered fireplace option is selected.

OPTIONAL SUNROOM W/ OPTIONAL DECK I

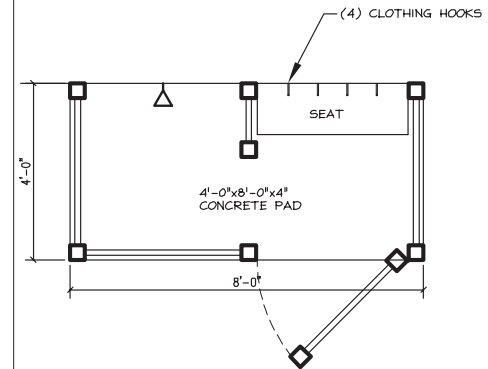
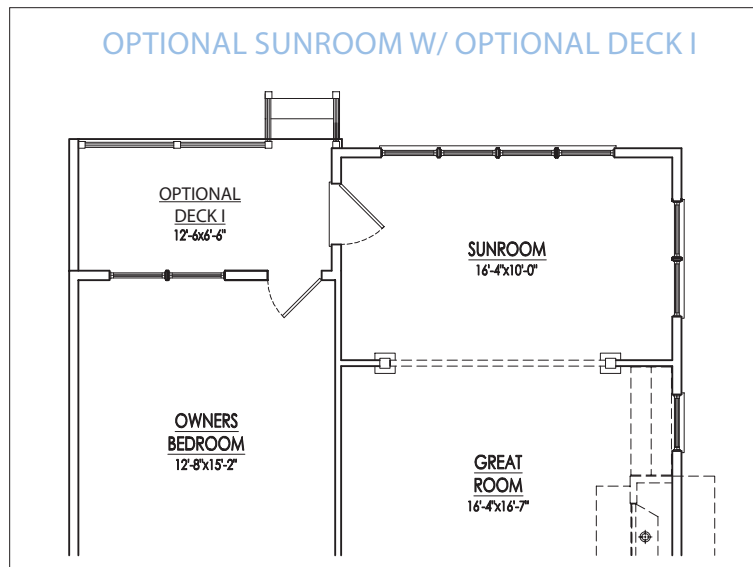

4' X 8' OUTDOOR SHOWER

To be located behind staircase wall.

OPTIONAL BEDROOM #4 W/ BATHROOM #3

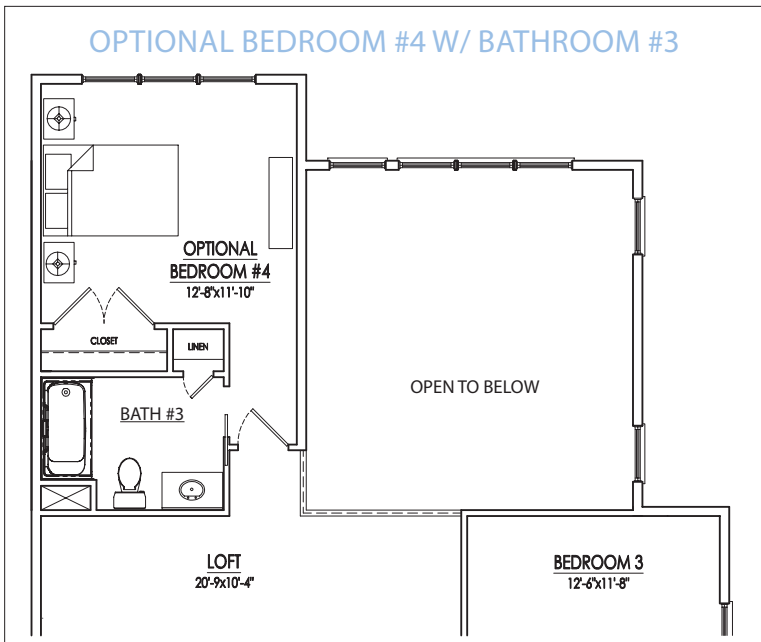

Additional Options on Back 

* All information is subject to change without notice.

Structural Options

